



2013/09/30

VALNÍKOVÉ NÁSTAVBY  
OPEN BODY SYSTEMS

## Zadní čelo dělené / Small rear doors



### ZADNÍ ČELO DĚLENÉ S VESTAVNÝM ZÁVĚREM / SMALL REAR DOORS WITH BUILT-IN LOCK

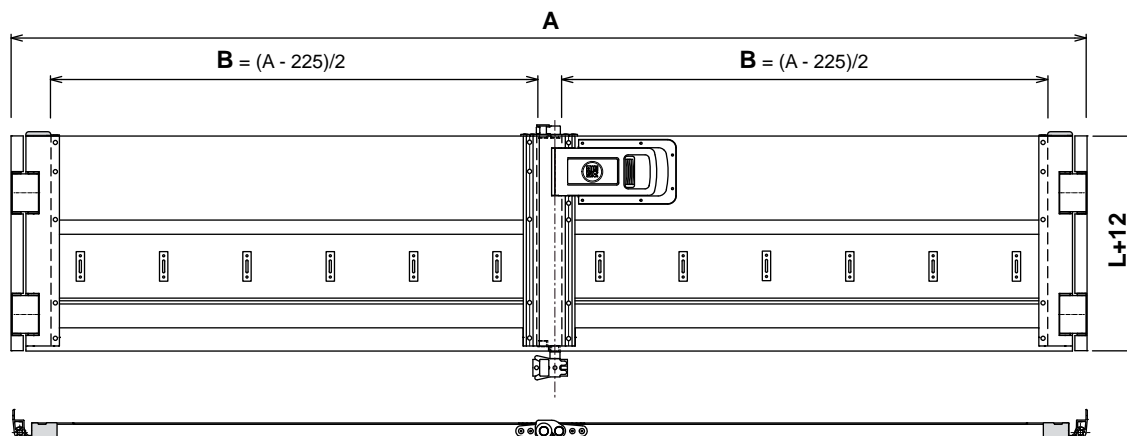

### ZADNÍ ČELO DĚLENÉ S PÁKOVÝM ZÁVĚREM / SMALL REAR DOORS WITH OUTSIDE LOCK

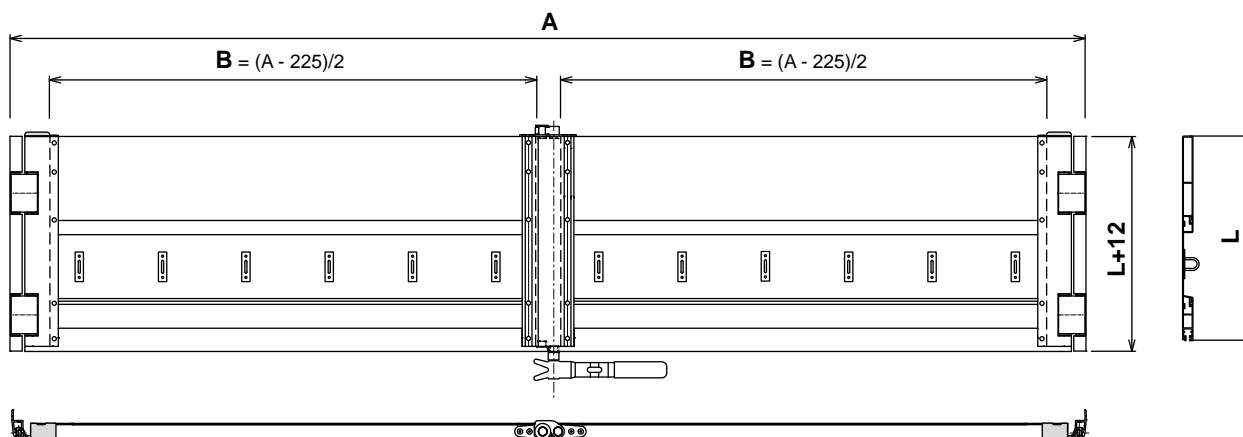

- A Vnější šířka nástavby / Total length
- B Délka profilů / Length of the profile
- C Výška bočnice / Side board height

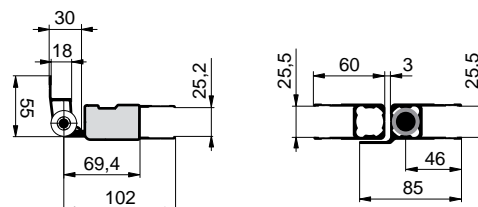

ZADNÍ ČELO DĚLENÉ

SMALL REAR DOORS

**PANTY ZADNÍCH VRÁTEK / HINGES OF SMALL REAR DOORS**

ZADNÍ ČELO DĚLENÉ

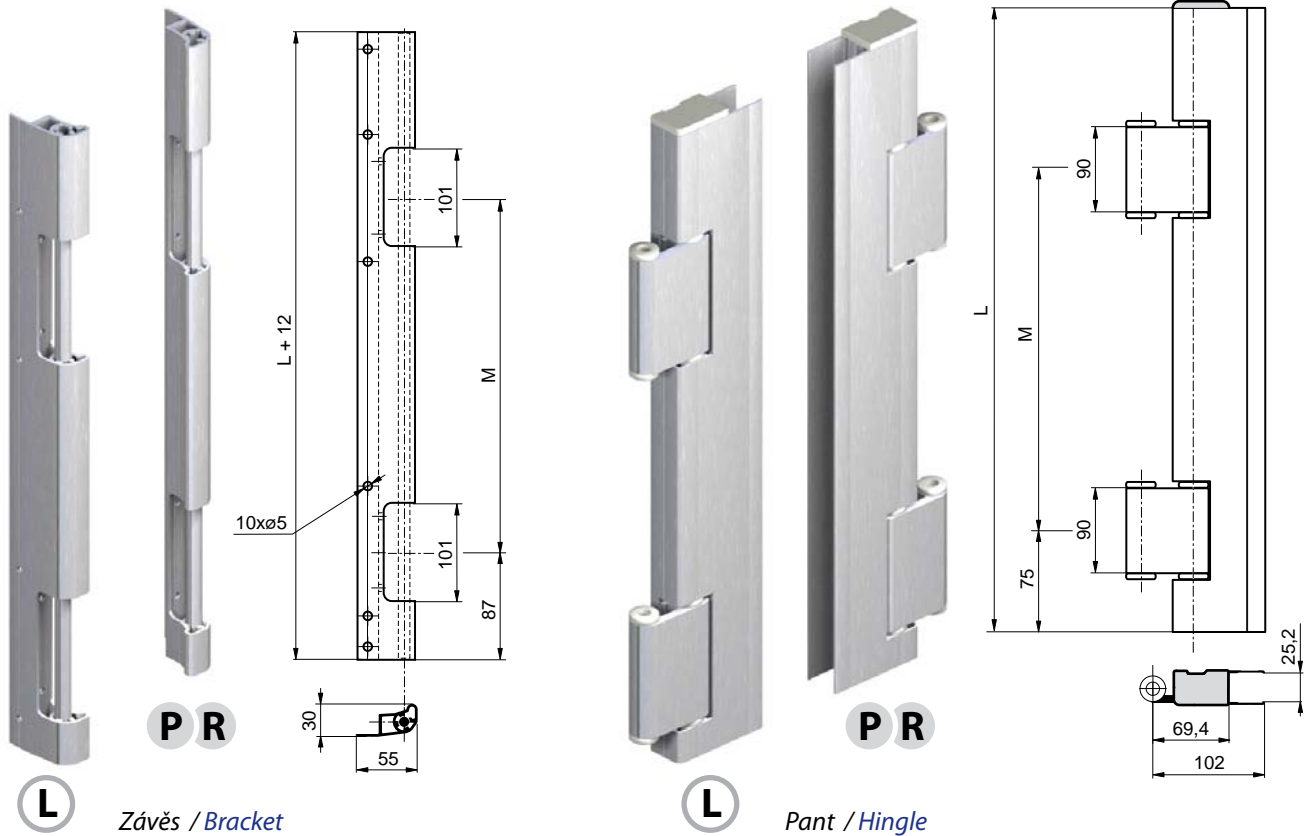
**Pant zadních vrátek / Hinge of small rear doors**

Obj. číslo Catalogue No.	L [mm]	M [mm]	Povrchová úprava Coating	Pozice Position	Hmotnost Weight [kg]
731210400L	400	290	elox / anod	L	1,56
731210400P	400	290	elox / anod	P/R	1,56
731210500L	500	290	elox / anod	L	1,56
731210500P	500	290	elox / anod	P/R	1,56
731210600L	600	390	elox / anod	L	1,90
731210600P	600	390	elox / anod	P/R	1,90
731210800L	800	590	elox / anod	L	2,50
731210800P	800	590	elox / anod	P/R	2,50

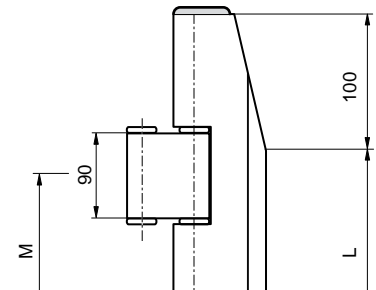
**731210400L**
**Závěs zadních vrátek / Bracket of small rear doors**

Obj. číslo Catalogue No.	L [mm]	M [mm]	Povrchová úprava Coating	Pozice Position	Hmotnost Weight [kg]
731210401L	500	290	elox / anod	L	0,425
731210401P	500	290	elox / anod	P/R	0,425
731210501L	500	290	elox / anod	L	0,425
731210501P	500	290	elox / anod	P/R	0,425
731210601L	600	390	elox / anod	L	0,540
731210601P	600	390	elox / anod	P/R	0,540
731210801L	800	590	elox / anod	L	0,740
731210801P	800	590	elox / anod	P/R	0,740



SMALL REAR DOORS





2013/09/30

VALNÍKOVÉ NÁSTAVBY  
OPEN BODY SYSTEMS

Obj. číslo Catalogue No.	Název / Name	Materiál Material	Hmotnost Weight [kg]
2506100214	Uzávěr vrátek 888 Lock 888	nerez / stst	1,800
42344510AY	Tyč závěru ø16mm, 1400mm Lock bar ø16mm, 1400mm	zn	2,000
2212621267	Profil lemovací A, zadních dveří Edging profile A, rear door	elox anod	1,319
2212621268	Profil lemovací h, zadních dveří Edging profile h, rear door	elox anod	1,551
62VPS16224	Sada pouzder pro zadní čelo dělené Set of sockets for small rear doors	plast plastic	0,010
2506093900	Háček závěru vrátek Lock hook 788.2	zn	0,13
BND3312510	Madlo s vidlicí zám.vrat 16mm Handle from lock 16mm	zn	2,750
BND3310810	Protikus madla zám.vrat 16mm Keeper from lock 16mm	zn	1,118
BND3312210	Vidlice zám.vrat 16mm H Gate lock fork 16mm H	zn	0,220
BND3310110	Protikus vidlice zám.vrat 16mm Keeper from lock 16mm	zn	0,378



2506100214

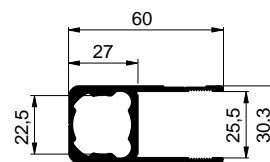

2212621267 - elox / anod

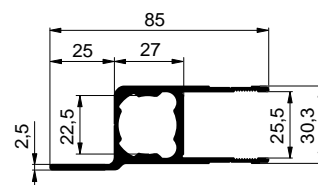

h2212621268 - elox / anod



BND3310110



BND3310810

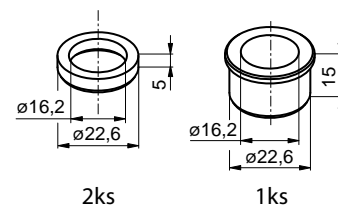

2ks

1ks

62VPS16224

2506002500

2506093900

2506002500

2506093900



BND3312510

6162013001

BND3312210

ZADNÍ ČELO DĚLENÉ

SMALL REAR DOORS

**TĚSNĚNÍ ZADNÍCH VRÁTEK / SEALING OF SMALL REAR DOORS**

ZADNÍ ČELO DĚLENÉ

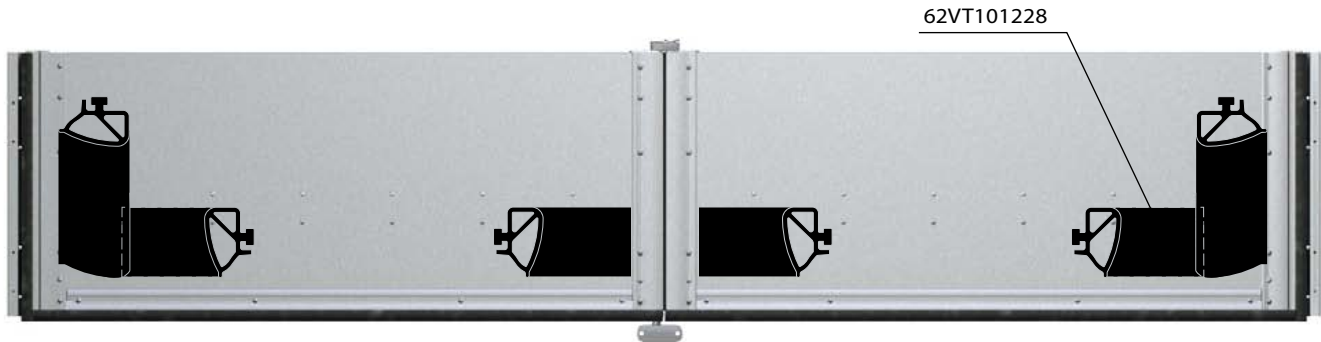

Vnitřní pohled / Inner view



Detail pantu / Detail view

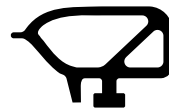

**62VT101228**



Zajištění těsnění / Safing

SMALL REAR DOORS



Vnější pohled / Outer view